

Design: Márk Nagy-Mihály
Year: 2021

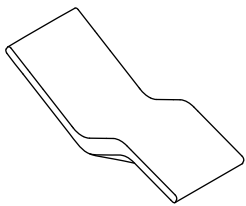

ELEMENTS

RLX-A



RLX-A-T
/ with side table

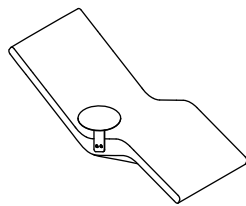

RLX-M
/ recessed

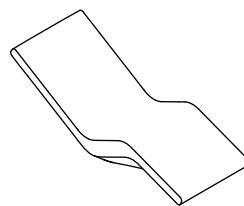

RLX-M-T
/ recessed with side table

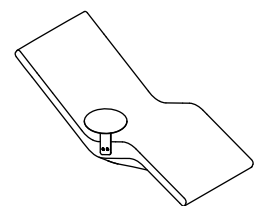

SAMPLE COMBINATIONS

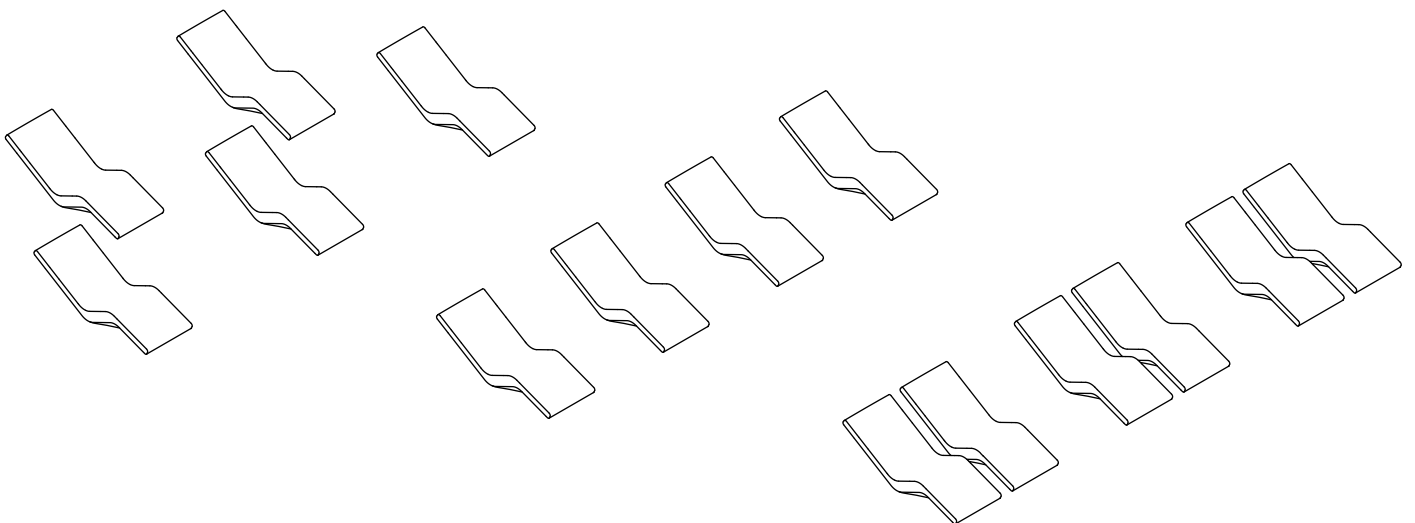

Design: Márk Nagy-Mihály

Year: 2021

INFO

Material:	high performance concrete (HPC)
Standard colour:	white
Finish:	natural cast
Treatment:	impregnated
Lifting:	with lifting straps
Placement:	on load-bearing, ready-to-use walking surface/ on concrete foundation
Fixing:	by anchoring
Cleaning:	with neutral detergent

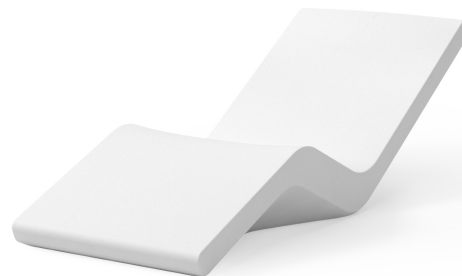

MEASUREMENTS

0 _____ 500 mm

RLX-A
650 kg

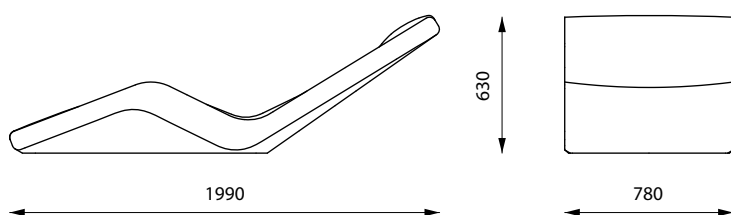

RLX-M/ recessed
760 kg

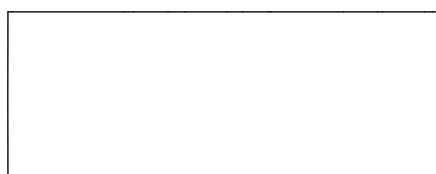
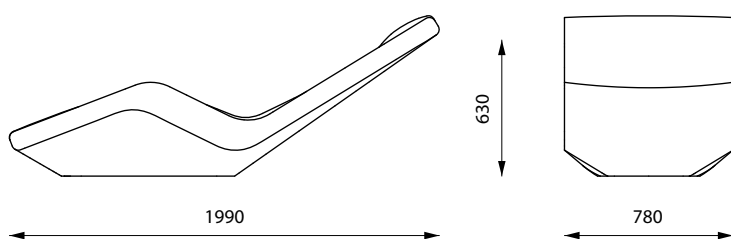

INSTALLATION

The product may be lifted with lifting straps. The product is fixed with antifreeze adhesive or with anchor bolts to load-bearing walking surface or to concrete foundation.

For further information see Installation Guide.

MAINTENANCE

The product may be cleaned with neutral detergent. For further information see Maintenance Guide.

Design: Márk Nagy-Mihály

Year: 2021

INFO

Material:	high performance concrete (HPC)
Standard colour:	white
Finish:	natural cast
Treatment:	impregnated
Metal:	powder coated galvanized steel
Standard metal colour:	anthracite gray – RAL 7016
Lifting:	with lifting straps
Placement:	on load-bearing, ready-to-use walking surface/ on concrete foundation
Fixing:	by anchoring
Cleaning:	with neutral detergent



MEASUREMENTS

0 _____ 500 mm

RLX-A-T/ with side table
650 kg

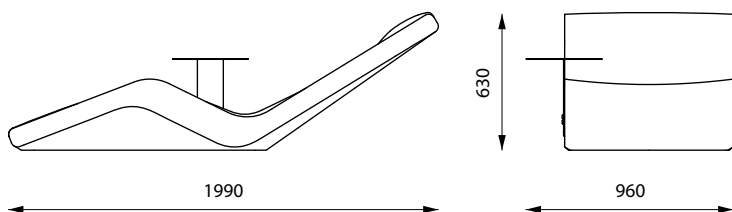

RLX-M-T/ recessed with side table
760 kg

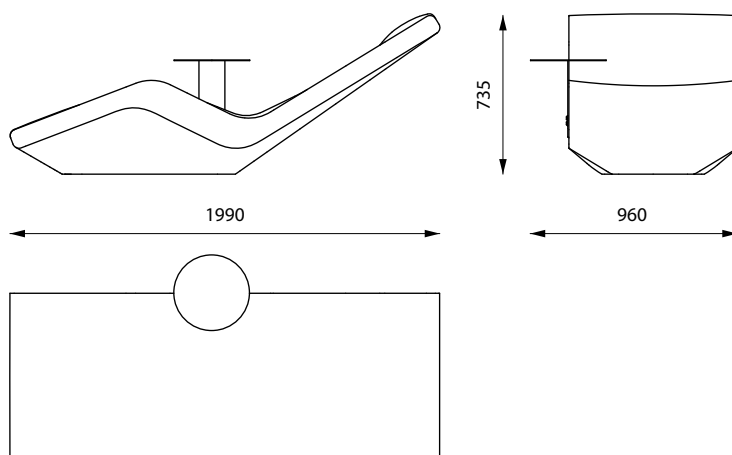

INSTALLATION

The product may be lifted with lifting straps. The product is fixed with antifreeze adhesive or with anchor bolts to load-bearing walking surface or to concrete foundation.

For further information see Installation Guide.

MAINTENANCE

The product may be cleaned with neutral detergent.

For further information see Maintenance Guide.